

X8C *GYROSCOPE 2.4G* **EXPLORERS**

4CH 2.4G REMOTE CONTROL QUADCOPTER

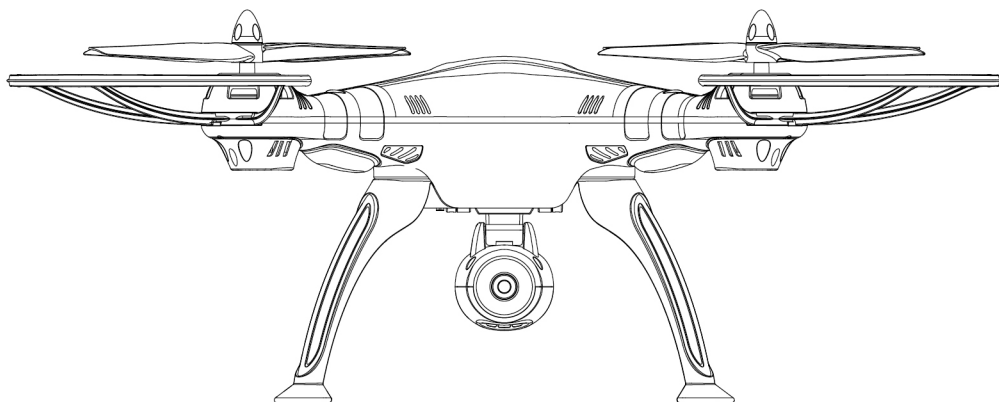

1 INSTRUCTION MANUAL

IMPLEMENT STANDARD: GB/T26701-2011

Main characteristics

- Four-axis structure is applied, which makes the quadcopter more flexible and rapid when flying. It has the characteristics of wind-resistant and can be flown indoor or outdoor.
- Built-in 6 axis gyroscope for precise hovering in the sky.
- Modular design structure is applied, more simple for assembly and convenient for maintenance.
- With 360° 3D eversion function and throwing flight function .
- Newly-increased headless function can recall the aircraft easily.

The materials and specification mentioned in this instruction manual or the parts inside this package is for reference only. Our company won't be responsible for any adaption of the outer package. Nor shall we keep our customers informed in advance. Any information updates or changes, please be subject to our website .

Safety regulations

1. Please put smaller parts of the aircraft in the place where children can't reach, avoiding from accidents.
2. Power of this aircraft is adequate. Therefore, when flying for the first time, it should push remote control's right/left variable-speed joystick slowly, avoiding from collisions caused by rising aircraft rapidly.
3. After flying, it should turn off remote control's power supply and come close to the aircraft to turn off its power supply.
4. Please don't put battery in high-temperature and heated places(such as fire or nearby electric heating devices).
5. When the aircraft flies, it should maintain 2-3 meters from the user or others, avoiding from crashing into others' head, face or body when it lands.
6. When children operate the aircraft, they should be accompanied with the adult and guided by the adult. Ensure that the aircraft is controlled within the range of operator's (or instructor's) visibility. It is convenient for controlling.
7. Non-rechargeable battery can't charge. As installing or changing battery, please pay attention to the polarity. Don't use a mixture of old and new battery or battery with different types.
8. When it isn't used, it should turn off remote power supply of remote control and aircraft, respectively, and take out the battery in remote control.
9. Power supply terminal can't be short circuit.

Maintenance

1. Use clean soft cloth to clean this product frequently.
2. Avoid from exposure or heating in the sun.
3. Don't put the toy in the water. Otherwise, it'll damage electronic parts.
4. Please check the plug and other accessories at regular intervals. If there is any damage, please stop using it immediately until it is repaired completely.

Contents

Product included following contents:

- Quadcopter
- Battery
- 2.4G Remote controller
- Four riggers
- USB charging wire
- Four foot stands
- Instruction manual
- Camera
- Screwdriver
- Reader
- Blade(4 pieces)



Get to know your transmitter

Introduction of transmitter:

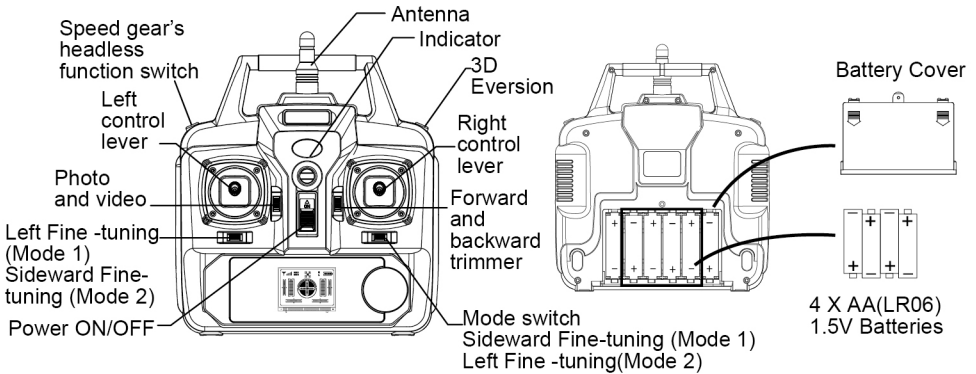

Installation methods of battery: Open back battery cover of remote control, and put 4 No.5 alkaline batteries in the middle place correctly, according to battery box's pole indication (battery should be available separately).



1. Install batteries with correct polarity.
2. Do not mix old and new batteries.
3. Do not mix different types of batteries.

Remote control keypad and lcd manual

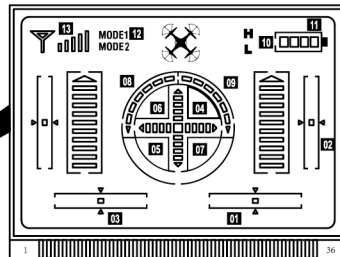
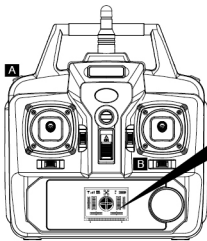

01. Sideward Fine-tuning :Power-on start in the centering.(Be turn Left/Right Fine -tuning in Mode2)
02. Forward/Backward fine-tuning:Power-on start in the middle.
03. Turn Left/Right fine-tuning:Power-on start in centering.(Be Sideward Fly Fine -tuning in Mode2)
04. Forward shows:Power-on start in the lowest level.(At the center square)
05. Backward shows:Power-on start in the lowest level.(At the center square)
06. Right sideward fly shows:Power-on start in the lowest level.(At the center square)
07. Left sideward fly shows:Power-on start in the lowest level.(At the center square)

08. Turn left: Pull left function lever to left, it will be higher, than quad copter turn left faster.
09. Turn right: Pull left function lever to right, it will be higher, than quad copter turn right faster.
10. High/Low speed: Press button "A" for seconds to switch between high speed mode or low speed mode. "H" means high speed and "L" means low speed.
11. Power shows: According to the battery's energy for the controller.
12. Default mode when power-on. When change to MODE 2, please keep pressing button "B" to right than return on the power of transmitter, the MODE on LCD displayer will be changed. Same steps to change to MODE 1 again.
13. Signal shows: Normally to full frame.

Installation steps of aircraft's safety guard



Figure (1)

1. Pull out ornamental parts as shown in Figure (1).



Figure (2)

2. Back out screws in anti-clockwise direction as shown in Figure (2).



Figure (3)

3. Press down ornamental parts as shown in Figure (3) and insert guard circle into fuselage interface.

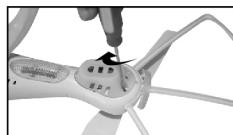

Figure (4)

4. Rotate and twist screws in clockwise direction as shown in Figure (4).

Note: Without rigger, rolling effect in flight will be better.

Installation steps of aircraft's foot stands

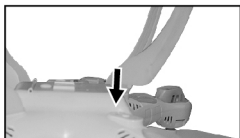

Figure (1)

1. Insert foot stands into interface of lower main body as shown in Figure (1).

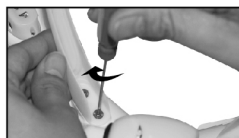

Figure (2)

2. Rotate and twist screws in clockwise direction as shown in Figure (2).

Install camera

Installation steps of X8C camera:



Figure (1)

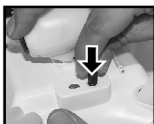

Figure (2)

1. Push the camera in place as shown in Figure (1).
2. Connect connecting line of camera with power supply socket of fuselage's camera as shown in Figure (2).

Disassembly steps of X8C Camera:

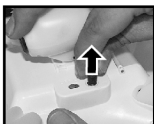

Figure (1)

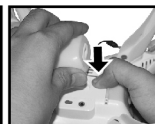

Figure (2)

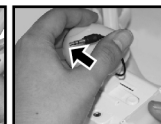

Figure (3)

1. Pull out power supply cable of the camera as shown in Figure (1).
2. Press down safe lock of lower main body as shown in Figure (2).
3. Push forward the camera and take it out as shown in Figure (3).

Note: After turning on aircraft's power supply, it forbids to insert or pull out the camera's plug connecting to the aircraft.

photography/video instructions

1. Methods: ① Make sure the 3-pin plug of camera is inserted to the quadcopter.
② Turn the quadcopter power on, the camera works normally when the RED indicator change form flashing to green and keep light on. If the RED indicator just light on and light off seconds later, it means the SD card is not in the camera. Please insert the SD card, than the indicator light on GREEN.
2. Get to know take photo and video:
 - ① Turn on the transmitter and pull left lever up and down to connect signal between quadcopter and transmitter.

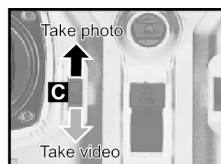

- ② Take Photo : Make sure camera normally work, when push the button “C” up, camera will take a photo after a beep from transmitter and the GREEN indicator on camera will be RED and flash on time.
- Take Video : Make sure camera normally work , when pull the button “C” down , camera starts to take video after a beep from transmitter and the GREEN indicator on camera will change to RED than keep flashing. Press the button “C” slightly again , another beep from transmitter means video stopped and the RED flashing light on camera will be GREEN and keep light on.

Controller modes & instructions

The transmitter built-in two modes, Mode 1 & Mode 2, in line with different customer's usage pattern. Keep pushing button B to right, than turn on the transmitter power to change Mode 1 or Mode 2.

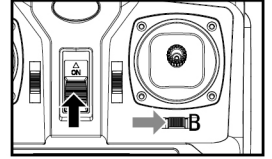

MODE 1

Operating direction

Hover up and down

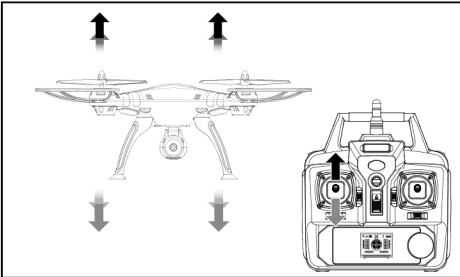

Push the throttle up or down, the quadcopter flies upward or downward.

Forward and backward

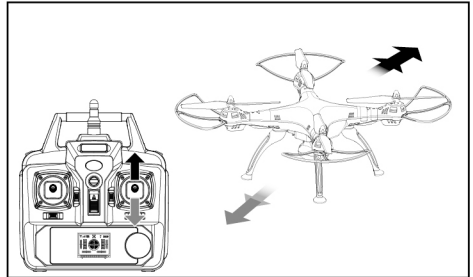

Push the direction lever up or down, the quadcopter flies forward or backward.

Turn Left and Right

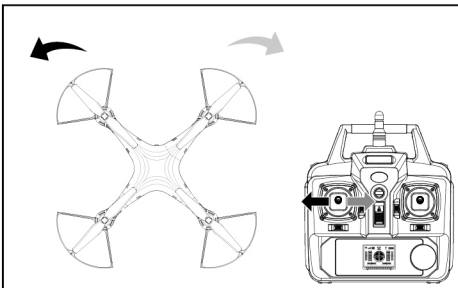

Pull the throttle left or right, the quadcopter turns to left or right.

Sideward fly

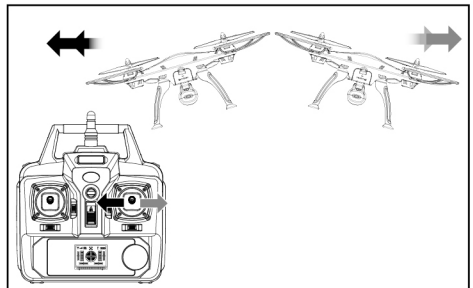

Pull the direction lever left or right, the quadcopter flies to left side or right side.

Fine-tuning operation

Forward/Backward fine-tuning

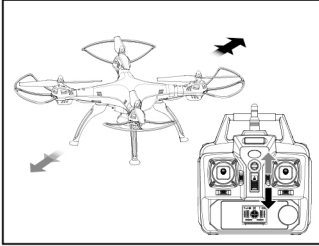

When the quadcopter keeps flying forward / backward, you can correct it by pressing fine-tuning button down / up.

Sideward fly fine-tuning

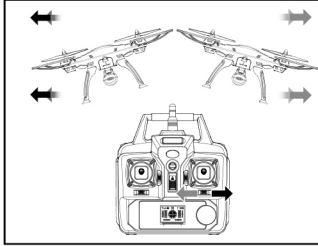

When the quadcopter keeps flying to left / right side, you can correct it by pressing the Fine-tuning button right / left.

Turn left/right fine-tuning

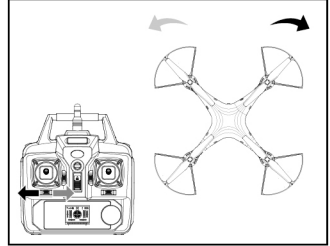

When the quadcopter keeps rotating to left / right, you can correct it by pressing the fine-tuning button right / left.

MODE 2

Operating direction

Hover up and down

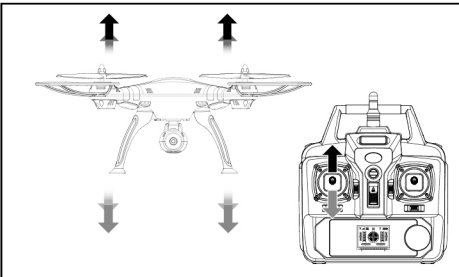

Push the throttle up or down, the quadcopter flies upward or downward.

Forward and backward

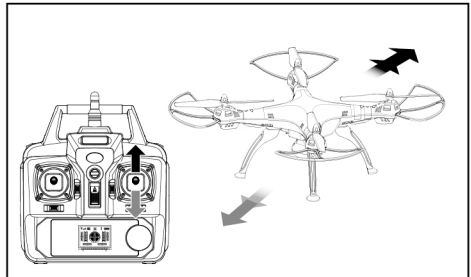

Push the direction lever up or down, the quadcopter flies forward or backward.

Turn Left and Right

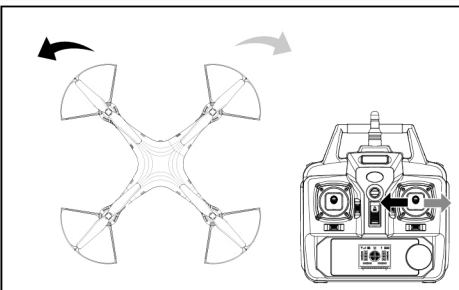

Pull the direction lever left or right, the quadcopter turns to left or right.

Sideward fly

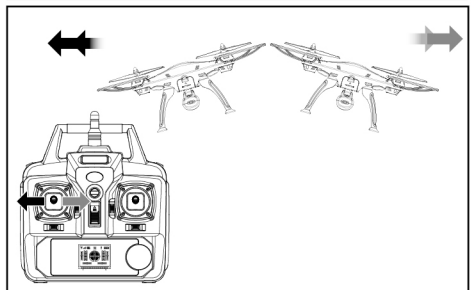

Pull the throttle left or right, the quadcopter flies to left side or right side.

Fine-tuning operation

Forward/Backward fine-tuning

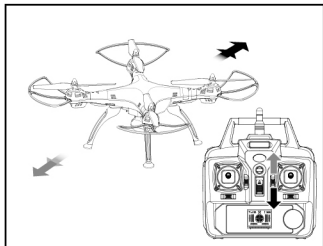

When the quadcopter keeps flying forward / backward, you can correct it by pressing fine-tuning button down / up.

Sideward fly fine-tuning

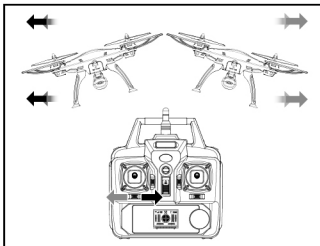

When the quadcopter keeps flying to left / right side, you can correct it by pressing the Fine-tuning button right / left.

Turn left/right fine-tuning

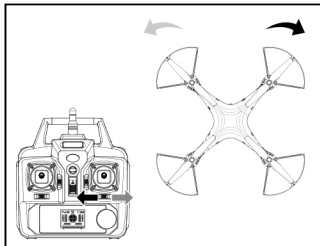

When the quadcopter keeps rotating to left / right, you can correct it by pressing the fine-tuning button right / left.

Ready to fly your quadcopter

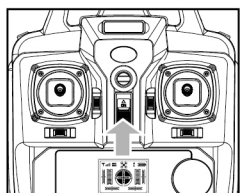

1. Press the ON/OFF power switch up.

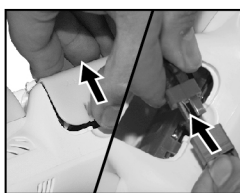

2. Open battery cover, and connect battery connector with dash receiver.

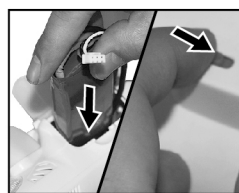

3. Enclose battery into the fuselage, after closing battery cover, turn on the switch on the bottom of aircraft.

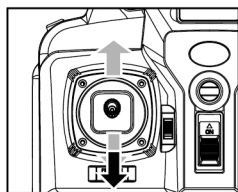

4. Push the throttle lever to the highest position, and then pull it back to the lowest position. There will be one clear sound from the transmitter, this shows that the quadcopter has entered into the pre-fly state.

Function introduction

1. Low-voltage protection:

When four indicator lights on the bottom of aircraft start to flicker, it means electric quantity of the aircraft is insufficient. Please control the aircraft to make a return voyage.

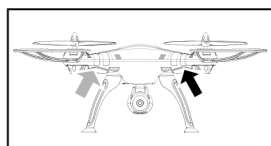

2.Low-voltage protection:

When four indicator lights on the bottom of aircraft start to flicker, it means electric quantity of the aircraft is insufficient. Please control the aircraft to make a return voyage.

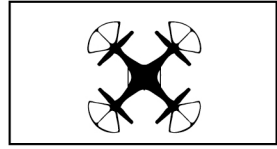

3.Horizontal correcting function:

Place the quadcopter on a horizontal position, then push transmitter both left and right lever to lowest right corner for about 2-3 second, indicator on the quadcopter changed from normal lights up to quickly flashing; After 2-3 second, the indicator changed to normal lights, it means the quadcopter restarted /reset successfully.

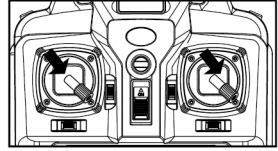

4.3D eversion:

When you are familiar with the basic operation, you can do some awesome& exciting tricks and stunts! First of all, fly the aircraft to a height of more than 3 meters, press the 3D Eversion switch on the rear right side of the transmitter, then push the right rudder(in any direction) to make 360 degree flip.

Tips:3D eversion goes better when battery power is enough.

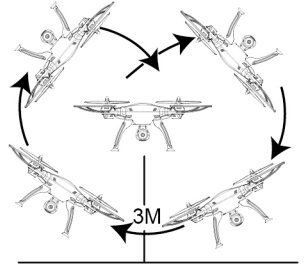

5.Headless function:

1. Forward definition

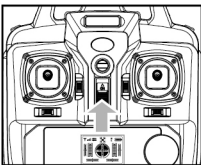

1. Turn on power switch of remote control.

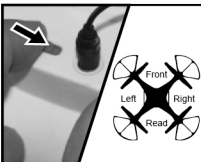

2. After aircraft connects with power supply, place the switch in "ON" position, adjust the direction pointed by aircraft's handpiece and regard it as the dead ahead in headless situation.

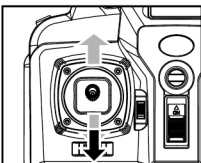

3. Push the accelerator's push rod of remote control to the highest point and pull back to the lowest point. When remote control pops, it indicates that frequency modulation and forward definition have already finished.

2. Switch to headless function and general function

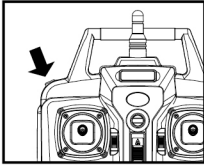

1. After frequency modulation, the aircraft defaults to general pattern. The indicator light on aircraft is long bright state. After pressing down headless function switch on the top left of master remote controller for 2 seconds, remote control will give out “DDD...”, it means that it enters into headless state. After pressing for 2 seconds and hearing long “D”, it means that it exits headless state. (In headless mode, four indicators on the aircraft flicker slowly for once within four seconds)

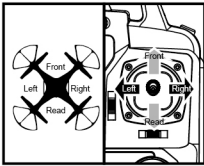

2. In headless state, the operator has no need to recognize the position of aircraft's headpiece, and he just needs to control the aircraft in accordance with the direction of remote control's operating rod.

3. Correcting forward direction

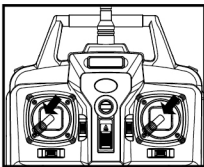

1. After aircraft crashes in headless state, if there is deviation in head direction, it just needs to adjust the aircraft's direction again, pull remote control's accelerator and operating rod to bottom left simultaneously. When indicator light on the aircraft flickers for slow three seconds, it means that correction is done.

Battery replacement and charging method

Steps of battery replacement:

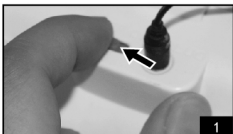

1. Turn off aircraft's power supply, and push the switch to “OFF”.

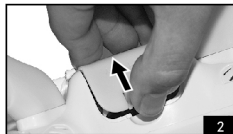

2. Open aircraft's battery cover backward.



3. Connect battery interface with dash receiver.

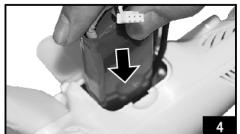

4. After battery replacement, fasten the battery cover again.

Steps of battery charge:

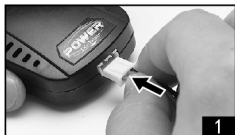

1. Connect battery switch with charger.



2. Connect charger to power supply socket.

Balanced charger:

1. Insert adapter's DC outlet into import socket of balanced charger. Red light of balanced charger will light on.
2. Insert three-position balanced plug of power battery to output end of charger. Green light of balanced charger will light on. When green light extinguishes, it means the end of battery charging.

(Charging time is less than 200 minutes)

Note: if power battery inserts into the charger, the light has no change. It indicates that this battery is full energy. There is no need to recharge.

Charging time: about 200 minutes Flying time: about 7 minutes!

Cautions when charging:

1. When charging, please put this product on a dried or ventilated area and keep it far away from heat source or explosive product.
2. When charging, please remove the batteries from the quadcopter. Then charging process should be supervised by an adult so as not to cause an accident.
3. After flying, please do not charge the battery if the surface temperature is still not cool. Otherwise it may cause a swollen battery or even a fire hazard.
4. Please make sure that you use the original USB charging cable provided. When the battery has been used for a long time, or appears to be swollen, please replace them.
5. A battery when not in use for a long time will lose its charge automatically. Charging or discharging too often may reduce the life of the battery.

Steps of fan blade's installation/disassembly of aircraft

Steps of fan blade's disassembly:



Figure (1)



Figure (2)



Figure (3)



Figure (4)

1. Rotate and back out fan blade cover in anti-clockwise direction as shown in Figure (1).
2. Rotate and back out screws in anti-clockwise direction as shown in Figure (2).
3. Pull out collar bush upward as shown in Figure (3).
4. Pull out fan blade upward as shown in Figure (4).

Installation steps of fan blade:



Figure (1)



Figure (2)



Figure (3)



Figure (4)

1. Insert fan blade into principal axis pipe as shown in Figure (1)
2. Insert collar bush into principal axis pipe as shown in Figure (2). Screw holes on the principal axis pipe should be aligned with the screw holes on the principal axis.
3. Aim at the connector of principal axis pipe, rotate and twist in clockwise direction as shown in Figure (3).
4. Rotate and twist fan blade cover in clockwise direction as shown in Figure (4).

Maintenance procedure

Problems	Causes	Solutions
Aircraft has no response	<ol style="list-style-type: none"> 1. Aircraft enters into low-voltage protection. 2. Electric quantity of remote control is insufficient, power indicator light will flicker. 3. Channel selection of remote control is inconsistent with aircraft's match codes. 	<ol style="list-style-type: none"> 1. Charge the aircraft. 2. Change remote control's battery. 3. Adjust channels of remote control and aircraft, and make them become consistent.
Aircraft's flying response is insensitive	<ol style="list-style-type: none"> 1. Insufficient remote control's electric quantity. 2. Remote control with the same frequency is transmitting interference. 	<ol style="list-style-type: none"> 1. Battery replacement. 2. Change the place where has no transmitting interference of the same frequency.
When hovering, side flight is formed	<ol style="list-style-type: none"> 1. Have no horizontal correction. 	<ol style="list-style-type: none"> 1. Conduct horizontal correction, as shown in p.8(3)(correcting function)
In headless state, it deviates to dead ahead	<ol style="list-style-type: none"> 1. Head deflection is caused by multiple collisions. 	<ol style="list-style-type: none"> 1. Define forward again, as shown in p.8(5)(headless function)

Spare parts

Here are alternative accessories. In order to provide convenience for customer purchasing, every component are marked. Accessories can be purchased from local dealer. Please specify the color when purchasing.



X8C-01
Upper body
(White / Black)



X8C-02
Lower body
(White / Black)



X8C-03
Landing skids
(White / Black)

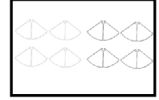

X8C-04
Protecting frames
(White / Black)

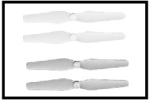

X8C-05
Rotating blades
(White / Black)



X8C-06
Reversing blades
(White / Black)



X8C-07
Ornament part

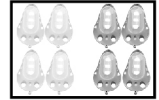

X8C-08
Motor holder
(White / Black)



X8C-09
Cear



X8C-10
Motor A

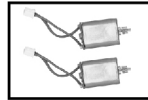

X8C-11
Motor B



X8C-12
Main stand



X8C-13
Blade cover

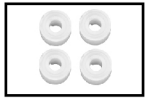

X8C-14
Spindle sleeve

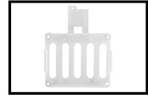

X8C-15
Base of Dash
Receiver

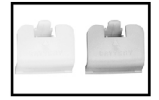

X8C-16
Battery cover
(White / Black)



X8C-17
Receiver board



X8C-18
Battery



X8C-19
A/B adaptor &
charge box

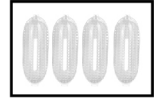

X8C-20
Lampshades



X8C-21
Transmitter



X8C-22
Reader



X8C-23
Camera
(White / Black)

Breakdown & Diagram

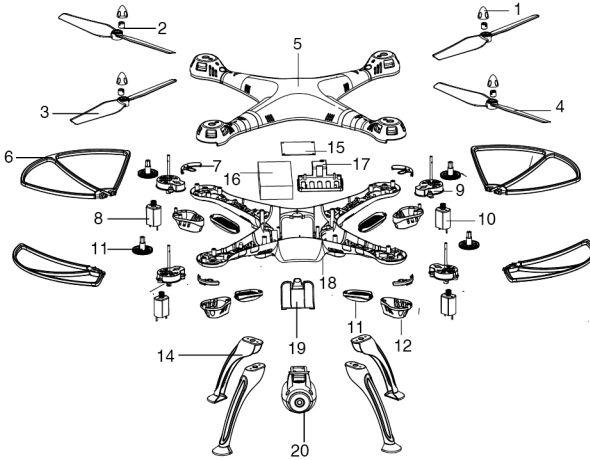

Code	Description	Quantity	Code	Description	Quantity	Code	Description	Quantity
1	Blade cover	4	8	Cear	4	15	Receiver board	1
2	Spindle sleeve	4	9	Main stand	4	16	Battery	1
3	Reversing blades	2	10	Reversing motor	2	17	Base of Dash Receiver	1
4	Rotating blades	2	11	Rotating motor	2	18	Lower body	1
5	Upper body	1	12	Motor cover	4	19	Battery cover	1
6	Protecting frames	4	13	Light boards	4	20	Camera	1
7	Ornament part	4	14	Landing skids	4			

Main parameter

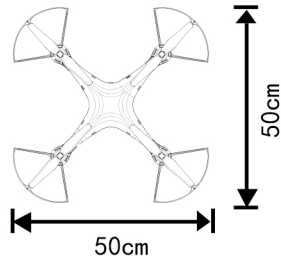
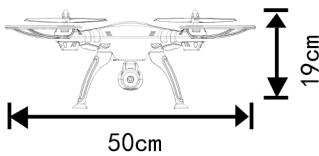

Length of fuselage: 50cm
 Width of fuselage: 50cm
 Height of fuselage: 19cm

Code of main engine: 132
 Battery: 7.4V 2000mAh



SPECIFICATIONS AND COLORS OF CONTENTS MAY VARY FROM PHOTO.

The company has the right of final interpretation of this instruction manual statement.